



Operator's Manual

E-200 MAX 50 with Direct Smart Reefer Single Temperature Systems

Revision A

Introduction

This manual is published for informational purposes only and the information furnished herein should not be considered as all-inclusive or meant to cover all contingencies. If more information is required, consult your Thermo King Service Directory for the location and telephone number of the local dealer.

Thermo King's warranty shall not apply to any equipment which has been "so installed, maintained, repaired or altered as, in the manufacturer's judgment, to affect its integrity."

Manufacturer shall have no liability to any person or entity for any personal injury, property damage or any other direct, indirect, special, or consequential damages whatsoever, arising out of the use of this manual or any information, recommendations or descriptions contained herein. The procedures described herein should only be undertaken by suitably qualified personnel. Failure to implement these procedures correctly may cause damage to the Thermo King unit or other property or personal injury.

There is nothing complicated about operating and maintaining your Thermo King unit, but a few minutes studying this manual will be time well spent.

Performing pre-trip checks and enroute inspections on a regular basis will minimize operating problems. A regular maintenance program will also help to keep your unit in top operating condition. If factory recommended procedures are followed, you will find that you have purchased the most efficient and dependable temperature control system available.

All service requirements, major and minor, should be handled by a Thermo King dealer for four very important reasons:

- They are equipped with the factory recommended tools to perform all service functions.
- They have factory trained and certified technicians.
- They have genuine Thermo King replacement parts.
- The warranty on your new unit is valid only when the repair and replacement of component parts is performed by an authorized Thermo King dealer.

Software License

The product includes software that is licensed under a non-exclusive, non-sublicensable, terminable and limited license to use the software as installed on the product for its intended purpose. Any removal, reproduction, reverse engineering, or other unauthorized use of the software is strictly prohibited. Hacking the product or installing unapproved software may void the warranty. The owner or operator shall not reverse engineer, decompile, or disassemble the software, except and only to the extent that such activity is expressly permitted by applicable law notwithstanding this limitation. The product may include third party software separately licensed as specified in any documentation accompanying the product or in an about screen on a mobile application or website that interfaces with the product.

Customer Satisfaction Survey

Let your voice be heard!

Your feedback will help improve our manuals. The survey is accessible through any internet-connected device with a web browser.

Scan the Quick Response (QR) code or click or type the web address https://tranetechnologies.iad1.qualtrics.com/jfe/form/SV_2octfSHoUJxsk6x?Q_CHL=qr&Q_JFE=qdg to complete the survey.



Table of Contents

Safety Precautions	7
Danger, Warning, Caution, and Notice	7
General Safety Practices	8
Automatic Start/Stop Operation	9
Battery Installation and Cable Routing	9
Refrigerant	11
Refrigerant Oil	12
First Aid	12
Safety Decals	14
Operation	14
High Voltage	14
Condenser and Evaporator Fans	15
Remote Start of the Unit	15
Refrigerant	16
Unit Description	17
Standard Unit Features	17
Optional Features	18
System Components	18
Compressor	18
Condenser	18
Evaporator	19
In-Cab Controller	19
SmartPower Operation	20
Electrical System	20
TK Lithium Ion Batteries (if equipped)	20
Fuses	21
Operating Instructions	23
Introduction	23

Unit Controls	24
Operating the Unit	25
Vehicle Engine Operation	25
Standby Operation	26
Entering the Setpoint Temperature	26
Single Temperature Units	26
.....	27
Initiating Manual Defrost Cycle	27
Alarms	28
Auto Start (after an alarm)	28
Manual Start (after an alarm)	29
Clearing Alarm Codes	30
Buzzers (Optional)	30
Alarm Code Descriptions	31
Viewing Information Displays	34
Main Menu	34
Hourmeter Menu	34
Unit Operation and Loading Procedures	35
Unit Operation (Before Loading Refrigerated Cargo)	35
Loading Procedure	35
Enroute Inspections	36
Inspection Procedure	36
Inspection Troubleshooting	37
Specifications	39
Refrigeration System	39
Compressor	39
Electrical Control System	39

Table of Contents

Electric Standby Power Supply Requirements 41
 Standby Power Plug Wiring 41

Inspection and Service Intervals 42

 Weekly Pre-Trip Checks 42
 Weekly Pretrip Inspection..... 42

 Weekly Post-Trip Checks 43

 Inspection and Service Schedules..... 44
 Service Record..... 44
 Preventative Maintenance 44

Warranty..... 45

 Proposition 65..... 45

Serial Number Locations 46

Recover Refrigerant..... 48

Emergency Cold Line 49

Safety Precautions

Danger, Warning, Caution, and Notice

Thermo King® recommends that all service be performed by a Thermo King dealer and to be aware of several general safety practices.

Safety advisories appear throughout this manual as required (refer to examples below). Your personal safety and the proper operation of this unit depend upon the strict observance of these precautions.

▲ DANGER

Example!

Indicates an imminently hazardous situation which, if not avoided, will result in death or serious injury.

▲ WARNING

Example!

Indicates a potentially hazardous situation which, if not avoided, could result in death or serious injury.

▲ CAUTION

Example!

Indicates a potentially hazardous situation which, if not avoided, could result in minor or moderate injury and unsafe practices.

NOTICE

Example!

Indicates a situation that could result in equipment or property-damage only accidents.

General Safety Practices

⚠ DANGER

Risk of Injury!

Keep hands and loose clothing clear of fans and belts at all times when the unit is operating with the doors open.

⚠ WARNING

Personal Protective Equipment (PPE) Required!

A battery can be dangerous. Lithium Ion batteries are potentially hazardous and can present a serious FIRE HAZARD if damaged, defective or improperly used. A battery stores enough electricity to burn you if it discharges quickly. Always wear goggles or safety glasses and personal protective equipment when working with a battery. Do not replace the battery with any type other than the one approved by Thermo King for this unit.

⚠ WARNING

Risk of Injury!

Do not apply heat to a closed cooling system. Before applying heat to a cooling system, drain it. Then flush it with water and drain the water. Antifreeze contains water and ethylene glycol. The ethylene glycol is flammable and can ignite if the antifreeze is heated enough to boil off the water.

⚠ WARNING

Risk of Injury!

Temperatures above 120 degrees F (50 degrees C) can cause serious burns. Use an infrared thermometer or other temperature measuring device before touching any potentially hot surfaces.

⚠ CAUTION

Sharp Edges!

Exposed coil fins can cause lacerations. Service work on the evaporator or condenser coils is best left to a certified Thermo King technician.

Automatic Start/Stop Operation

⚠ CAUTION

Risk of Injury!

The unit can start and run automatically any time the unit is turned on. Turn the unit On/Off switch Off before doing inspections or working on any part of the unit. Please note that only Qualified and Certified personnel should attempt to service your Thermo King unit.

Battery Installation and Cable Routing

⚠ WARNING

Hazard of Explosion!

An improperly installed battery could result in a fire, explosion, or injury. A Thermo King approved battery must be installed and properly secured to the battery tray.

⚠ WARNING

Hazard of Explosion!

Improperly installed battery cables could result in a fire, explosion, or injury. Battery cables must be installed, routed, and secured properly to prevent them from rubbing, chaffing, or making contact with hot, sharp, or rotating components.

⚠ WARNING

Fire Hazard!

Do not attach fuel lines to battery cables or electrical harnesses. This has the potential to cause a fire and could cause serious injury or death.

⚠ WARNING

Personal Protective Equipment (PPE) Required!

A battery can be dangerous. Lithium Ion batteries are potentially hazardous and can present a serious FIRE HAZARD if damaged, defective or improperly used. A battery stores enough electricity to burn you if it discharges quickly. Always wear goggles or safety glasses and personal protective equipment when working with a battery. Do not replace the battery with any type other than the one approved by Thermo King for this unit.

Safety Precautions

⚠ WARNING

Hazard of Explosion!

Always cover battery terminals to prevent them from making contact with metal components during battery installation. Battery terminals grounding against metal could cause the battery to explode.

⚠ CAUTION

Hazardous Service Procedures!

Set all unit electrical controls to the OFF position before connecting battery cables to the battery to prevent unit from starting unexpectedly and causing personal injury.

NOTICE

Equipment Damage!

Do not connect other manufacturer's equipment or accessories to the unit unless approved by Thermo King. Failure to do so can result in severe damage to equipment and void the warranty.

Refrigerant

Although fluorocarbon refrigerants are classified as safe, use caution when working with refrigerants or in areas where they are being used.

⚠ DANGER

Hazardous Gases!

Refrigerant in the presence of an open flame, spark, or electrical short produces toxic gases that are severe respiratory irritants which can cause serious injury or possible death.

⚠ DANGER

Refrigerant Vapor Hazard!

Do not inhale refrigerant. Use caution when working with refrigerant or a refrigeration system in any confined area with a limited air supply. Refrigerant displaces air and can cause oxygen depletion, resulting in suffocation and possible death.

⚠ WARNING

Personal Protective Equipment (PPE) Required!

Refrigerant in a liquid state evaporates rapidly when exposed to the atmosphere, freezing anything it contacts. Wear butyl lined gloves and other clothing and eye wear when handling refrigerant to help prevent frostbite.

Refrigerant Oil

Observe the following precautions when working with or around refrigerant oil:

⚠ WARNING

Personal Protective Equipment (PPE) Required!

Protect your eyes from contact with refrigerant oil. The oil can cause serious eye injuries. Protect skin and clothing from prolonged or repeated contact with refrigerant oil. To prevent irritation, wash your hands and clothing thoroughly after handling the oil. Rubber gloves are recommended.

***Important:** Please note that it is recommended to evacuate all passengers if a refrigerant leak is suspected. Please use your own specific company evacuation procedure.*

First Aid

REFRIGERANT

- **Eyes:** For contact with liquid, immediately flush eyes with large amounts of water and get prompt medical attention.
- **Skin:** Flush area with large amounts of warm water. Do not apply heat. Remove contaminated clothing and shoes. Wrap burns with dry, sterile, bulky dressing to protect from infection. Get prompt medical attention. Wash contaminated clothing before reuse.
- **Inhalation:** Move victim to fresh air and use Cardio Pulmonary Resuscitation (CPR) or mouth-to-mouth resuscitation to restore breathing, if necessary. Stay with victim until emergency personnel arrive.
- **Frost Bite:** In the event of frost bite, the objectives of First Aid are to protect the frozen area from further injury, warm the affected area rapidly, and to maintain respiration.

REFRIGERANT OIL

- **Eyes:** Immediately flush with large amounts of water for at least 15 minutes. Get prompt medical attention.
- **Skin:** Remove contaminated clothing. Wash thoroughly with soap and water. Get medical attention if irritation persists.
- **Inhalation:** Move victim to fresh air and use Cardio Pulmonary Resuscitation (CPR) or mouth-to-mouth resuscitation to restore

breathing, if necessary. Stay with victim until emergency personnel arrive.

- **Ingestion:** Do not induce vomiting. Immediately contact local poison control center or physician.

ENGINE COOLANT

- **Eyes:** Immediately flush with large amounts of water for at least 15 minutes. Get prompt medical attention.
- **Skin:** Remove contaminated clothing. Wash thoroughly with soap and water. Get medical attention if irritation persists.
- **Ingestion:** Do not induce vomiting. Immediately contact local poison control center or physician.

BATTERY ACID

- **Eyes:** Immediately flush with large amounts of water for at least 15 minutes. Get prompt medical attention. Wash skin with soap and water.

ELECTRICAL SHOCK

Take IMMEDIATE action after a person has received an electrical shock. Get quick medical assistance, if possible.

The source of the shock must be quickly stopped, by either shutting off the power or removing the victim. If the power cannot be shut off, the wire should be cut with a non-conductive tool, such as a wood-handle axe or thickly insulated cable cutters. Rescuers should wear insulated gloves and safety glasses, and avoid looking at wires being cut. The ensuing flash can cause burns and blindness.

If the victim must be removed from a live circuit, pull the victim away with a non-conductive material. Use wood, rope, a belt or coat to pull or push the victim away from the current. **DO NOT TOUCH** the victim. You will receive a shock from current flowing through the victim's body. After separating the victim from power source, immediately check for signs of a pulse and respiration. If no pulse is present, start Cardio Pulmonary Resuscitation (CPR). If a pulse is present, respiration might be restored by using mouth-to-mouth resuscitation. Call for emergency medical assistance.

ASPHYXIATION

Move victim to fresh air and use Cardio Pulmonary Resuscitation (CPR) or mouth-to-mouth resuscitation to restore breathing, if necessary. Stay with victim until emergency personnel arrive.

Safety Decals

Operation

The Operator Manual decal is located in an appropriate position near your in-cab controller (HMI). This decal gives you the information to access/download your unit operator manual.

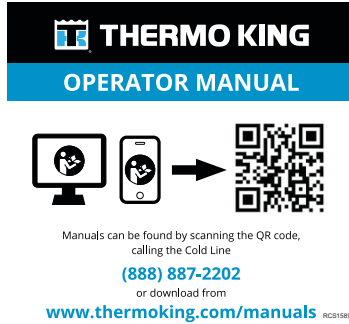

High Voltage

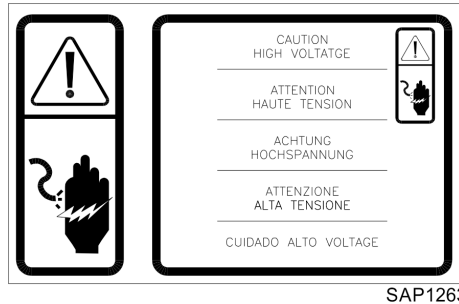

Decal located on the Compressor Drive Module - Condenser fan area.

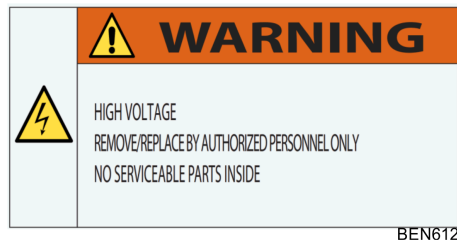

Condenser and Evaporator Fans

Be aware of the warning decals in the following locations:

- On belt guard
- On rear of evaporator housing

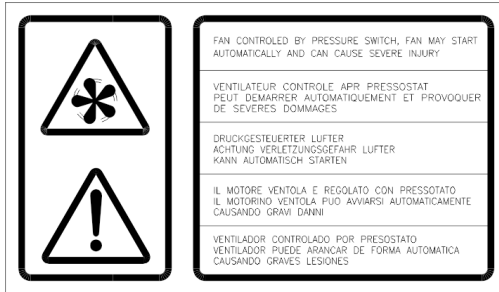

BEN580

Remote Start of the Unit

⚠ CAUTION

Risk of Injury!

The unit can start and run automatically any time the unit is turned on. Turn the unit On/Off switch Off before doing inspections or working on any part of the unit. Please note that only Qualified and Certified personnel should attempt to service your Thermo King unit.

Decals located on the cover of the electrical box, condenser section.

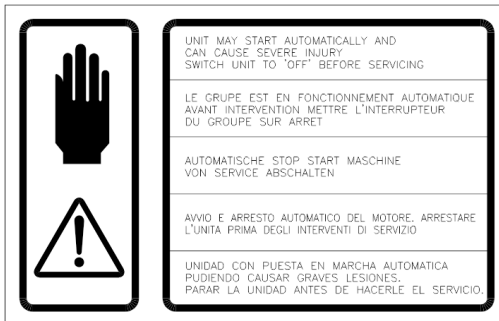

BEN581

Refrigerant

Decal is located adjacent to the service ports for charging or recovering the gas.

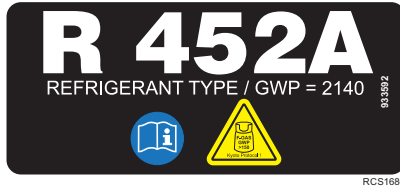

Unit Description

The Thermo King E-200 MAX 50 is a fully electric two-piece refrigeration unit comprised of a condenser and a remote evaporator designed for fresh and frozen applications on small trucks and vans.

During road operation, energy is provided by the vehicle to power the unit's variable speed hermetic compressor. SmartPower™ electric standby allows the unit to operate when the vehicle is stationary and connected to shore power.

The user friendly Direct Smart Reefer (DSR) controller makes operating your unit simple, while its modular design allows for ease of service.

E-200 MAX 50 operating range and features are:

- **Operating Range:** For frozen temperature applications down to -18C (0F).
- **Features:** Hot gas Heat, Cool and Defrost.

Standard Unit Features

- **Condenser** - Lightweight design of aluminum construction, easy to service with automotive grade polypropylene cover.
- **Evaporator** - Ultra slim design, lightweight aluminum construction with automotive grade Acrylonitrile Butadiene Styrene (ABS) cover.
- **Controls** - User friendly Direct Smart Reefer (DSR) In-Cab controller.
- **Refrigerant** - R-452A
- **SmartPower™** - Electric Standby
- **Hold-over functionality** - using extended vehicle battery to allow the user to maintain the temperature control of the compartment for a certain period when there is no alternator or stand-by power sources available. Needs Dealer activation.
- **Start/Stop and Increased Idle Speed Functionality** - improves the refrigeration performance during long periods of engine stops due to vehicle START/STOP activation/vehicle running in idle (e.g. traffic jam, urban distribution with high density of traffic lights). Needs Dealer activation and installation according to each chassis OEM's conversion manual.

Optional Features

- Door Switch Kit

***Note:** Installing door switches is strongly recommended if the application will use holdover mode.*

- Snow Covers
- Refrigeration Hose / Harness Covers
- TracKing® wireless asset management system
- **Thermo King Lithium Ion Batteries** - This option allows to get up to 2 x 1.8kWh Li-ion batteries mounted in the driver's cabin. This will keep the refrigeration unit in operation while the vehicle is stopped and cannot be connected to shore power. This is useful to hold the cargo box temperature during the following circumstances for example: deliveries to customers, lunch breaks etc. without the need to return to base. Each battery can support the refrigeration unit operating more than 1 hour in standard conditions. This option is not compatible with using extended vehicle battery for short holdover times.
- Electric Standby Plug (230V single phase 50Hz/60Hz or 115V single phase 60Hz options)

***Note:** Some options are available factory installed or as a retrofit option to suit individual customer needs.*

System Components

The system consists of the following main components:

Compressor

With E-Series units, mobile operation and electric standby modes operate with a variable speed hermetic compressor driven by an DC/AC inverter. Power is taken from vehicle battery or auxiliary batteries in mobile operation or from shore power in electric standby.

Condenser

The condenser is located on the roof of the vehicle or on the front of the cargo box. The cover can easily be removed to access the fuses or service the unit.

Figure 1. Condenser



Evaporator

The evaporator is mounted on the ceiling inside the cargo box. The cover can easily be removed for service.

Figure 2. Evaporator



In-Cab Controller

⚠ WARNING

Risk of Injury!

Never operate the unit unless you completely understand the controls; otherwise serious injury may occur.

The Direct Smart Reefer (DSR) Controller is mounted in the vehicle cab and is used to operate the refrigeration unit. Refer to Operating Instructions (["Introduction," p. 23](#)).

Figure 3. DSR In-Cab Controller

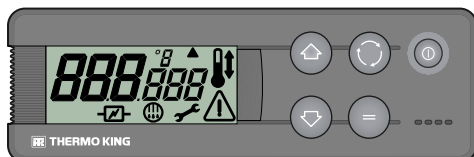

RCS360

SmartPower Operation**⚠ WARNING****Hazardous Voltage!**

A certified electrician should verify that the proper standby power requirements are being supplied before connecting to a new power source.

The unit may be operated in electric standby mode (SmartPower) by connecting the proper voltage power cable to the unit's power receptacle mounted on the vehicle. Standby operation is used while the vehicle is stationary with the engine shut off.

Figure 4. Standby Power Receptacle and Power Cable Shown

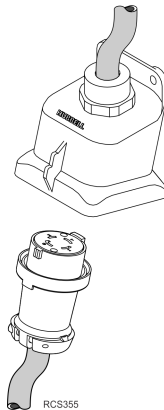
**Electrical System**

The unit's controls and refrigeration components operate on 12 Vdc.

SmartPower units have a standby motor that operates on 115 or 230 Vac when connected to a remote power source. A transformer in the condenser unit converts the 115 or 230 Vac to 12 Vdc to operate the unit's controls and refrigeration components.

TK Lithium Ion Batteries (if equipped)

When TK Battery option is present, some components are installed in the condenser:

- Smart Charger Module (SCM): converter for battery charging and discharging. The SCM has the ability to intelligently manage different

power sources. It has also a Smart (dis)charging system to use with the additional battery pack.

- Two DC relays (K2 and K3): for battery connection to E-200 internal DC bus.
- Battery Management System (BMS): Lithium battery protection and diagnostics.

The TK battery system has two main purposes:

- Gives power to the E-200 refrigeration system when the vehicle is off and the shore power is not connected. The batteries will connect automatically and will be able to run the unit for 1 hour with 1 TK battery is installed, or 2 hours with 2 TK batteries (time estimated depending the application).
- Gives support to the vehicle alternator when is not enough power to run and a voltage drop in main vehicle battery is present.

The TK battery is charged when the unit is connected to shore power, or when the unit is running in road mode and there is enough power to charge the batteries when the unit is running.

Fuses

The electrical components are protected by various fuses.

Main Power Fuse - The main power fuse is located in the vehicle's engine compartment and is connected directly to the vehicle's battery (or extended hold-over battery if fitted).

This 150 amp in-line fuse is non-serviceable and must only be replaced by an authorized Thermo King Dealer.

TK Battery Fuses - Each Battery is protected by a fuse installed inside the metal battery enclosure. If one battery is installed, the fuse must be 150A dc MEGA type. If two batteries an 80A dc MEGA type must be installed inside the metal battery enclosure. These fuses are non-serviceable and must only be replaced by an authorized Thermo King Dealer.

Smart Charger Module Fuses - Inside the electrical cabinet there are two fuses (F71 and F72) for the SCM protection, one in the input and one in the output (60A MIDI type).

BMS Supply Fuses - There are two **non-serviceable** fuses inline with the harness (F84 and F8) and installed inside the electrical cabinet that is protecting the BMS supply. These fuses are 10A dc rating.

Unit Description

Ignition Power Fuse - The ignition power fuse is connected to the vehicle's fused ignition system. Depending on the vehicle, the location of the fuse panel could be located inside the cab or under the hood of the vehicle.

Unit Component Fuses - These fuses are located in the condenser unit. Remove the condenser cover to access them. Depending on your model, some fuses may not be used.

Figure 5. Fuse Location (condenser cover and electric box cover removed)

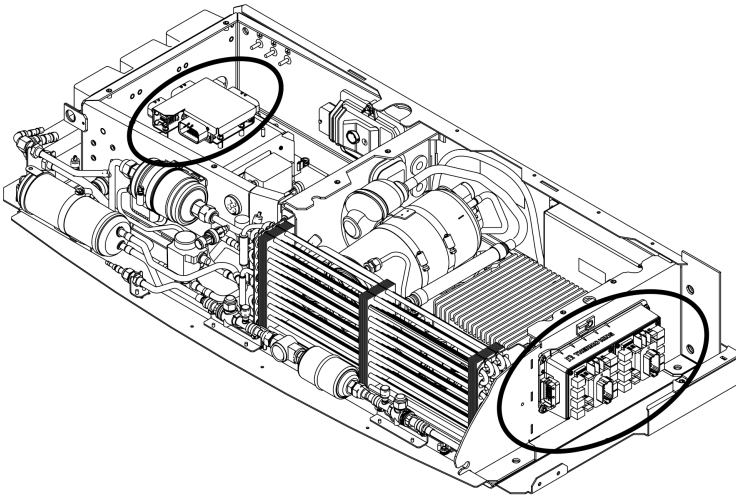

BEN859

Operating Instructions

Introduction

In vehicle powered units, temperature control is based on two values: The setting (Setpoint) of the controller and the evaporator return air temperature. The difference between these two temperatures will determine the mode of operation: cool, heat, or null.

Cool: When the temperature in the compartment is 3°F (2°C) *higher* than the setpoint, the unit runs in cool mode to reduce the evaporator return temperature to achieve the setpoint.

Heat: When the temperature in the compartment is 3°F (2°C) *lower* than the setpoint, the unit changes to heat mode to raise the evaporator return temperature to achieve the setpoint.

Null: Once the Setpoint Temperature has been reached, and the temperature remains at or within the temperature differential, (there is no demand for heat or cool), the unit stops operating and goes into the Null mode.

While in the Null mode, the unit is still monitoring the compartment temperature and will resume operation only if the temperature increases or decrease by 3°F (2°C) above or below the setpoint.

Defrost: After a period of time in cool mode, (time is setup during installation between 0 and 8 hours), the unit checks the coil temperature. If the temperature is cold enough to form ice, the unit runs in automatic Defrost Mode to eliminate ice that has accumulated in the evaporator coil. Defrost can also be initiated manually by selecting the defrost mode on the DSR controller. The unit will run in defrost until one of the two events occurs: 1) the coil temperature is back within range, or 2) the defrost termination timer has expired. (time is setup during installation).

Note: *The return air temperature will increase slightly while in defrost, however it will quickly return to the desired setpoint after completion of the defrost cycle.*

Unit Controls

⚠ WARNING

Risk of Injury!

Never operate the unit unless you completely understand the controls; otherwise serious injury may occur.

Figure 6. In-cab Control Panel (HMI) Display, Keys, Symbols

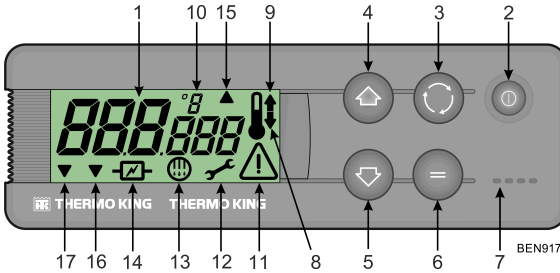

1. Display	It is always active and backlit except when the unit is disconnected (no power) or when the unit is connected but has been manually switched off from the HMI. It normally displays the return air temperature (of both load compartments in multi-temperature units).
2. On/Off Key	This key is used to start/stop the unit. It is always lit except when the unit is disconnected (no power), and thus acts as an indicator of the presence of power in the unit.
3. Select Key	Selects prompt screens and information screens.
4. Up Key	Is used to increase the setpoint temperature.
5. Down Key	Is used to reduce the setpoint temperature.
6. Enter Key	Is used to enter a new command such as manual defrost, etc.
7. Buzzer	It is energised when the vehicle battery and the electric power supply are connected simultaneously. It is also energized if the doors are opened while the refrigeration unit is running.
8. Cool Symbol	(Thermometer with an arrow pointing downward). The unit is cooling.
9. Heat Symbol	(Thermometer with an arrow pointing upward). The unit is heating.
10. °C/°F Symbol	Indicates whether the on-screen temperature reading is in degrees Celsius (C) or degrees Fahrenheit (F).

11. Alarm Symbol	Indicates that there is an alarm in the system.
12. Maintenance Symbol	Warns of the need to carry out maintenance to the unit.
13. Defrost Symbol	Indicates the unit is in Defrost Mode.
14. Electrical Symbol	Indicates that the unit is in Electric Standby.
15. Battery Status	If the unit is connected to shorepower and this symbol is solid, this means that the TK Batteries are charged. If this symbol is blinking, this means that the E-200 is charging the TK batteries.
16. Combined Compartment Symbol	Indicates that the multi-temperature unit is working as a single temperature unit.
17. Unit Derating mode.	Indicates the compressor is running in derating mode. This means that the controller is reducing the power delivered due to a particular battery voltage. When the battery voltage rises sufficiently, this mode is disabled and this icon will no longer appear.

Operating the Unit

Vehicle Engine Operation

1. Start the vehicle's engine.
2. Press the On/Off Key on the DSR controller. The Standard Display will appear.

The Standard Display normally displays the return air temperature and the current operating mode with the appropriate symbol. The example below shows: 38 F temperature and cool mode with an alarm present.

If an alarm is present, the Alarm symbol will also appear on the display. Refer to ("[Alarm Code Descriptions](#)," p. 31).

3. Check the setpoint, and adjust if necessary. Refer to ("[Entering the Setpoint Temperature](#)," p. 26).

THERMO KING

Operating Instructions

Figure 7. Standard Display

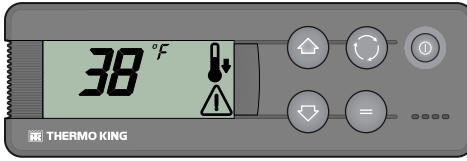

Standby Operation

1. Connect the external power supply to the electric power receptacle. Verify the power supply is the correct voltage, phase and frequency for unit.
2. Press the On/Off Key on DSR controller. The display will be activated. The electric symbol will appear on the display.
3. Check the setpoint, and adjust if necessary. Refer to ("[Entering the Setpoint Temperature](#)," p. 26).

Note: *When the unit is connected to an electric power source, engine driven operation is automatically blocked. If the vehicle engine is started up while the power cable is still connected to the electric power source, the unit will continue to operate in electric standby mode and the buzzer will sound (if enabled)*

Figure 8. Standard Display with Standby Symbol

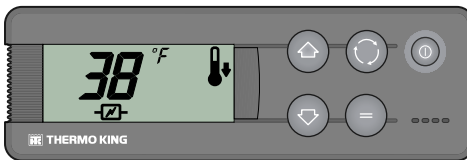

Entering the Setpoint Temperature

The Setpoint Temperature can be quickly and easily changed.

Single Temperature Units

1. Press and release the Select key twice and the current Setpoint Temperature and the letters SP will appear on screen.

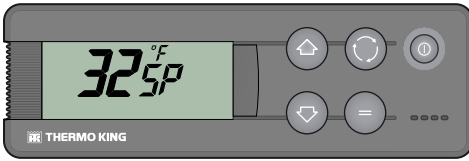

RCS366

2. Press the Up or Down arrow keys to select the desired Setpoint Temperature. Each time either of these buttons is pressed and released, the Setpoint Temperature will change one degree.
3. Press and release ENTER key to set the setpoint or press and release SELECT key to set the setpoint and return to the Standard Display.

Important: *If the Select key is not pressed within 20 seconds to select the new Setpoint Temperature, the unit will continue to run at the original Setpoint Temperature.*

Note: *Once the setpoint has been entered unit operation is fully automatic.*

Initiating Manual Defrost Cycle

Important: *Before initiating a manual defrost, verify that the unit is not already in a defrost cycle. When the unit is in a defrost cycle the defrost symbol appears on display.*

1. Press and release the Select key once, and the letters dEF will appear (flashing) on display along with the present defrost condition OFF.

Figure 9. Defrost Off

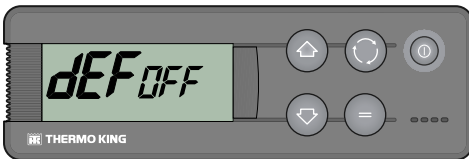

RCS371

2. To activate manual defrost, press the Enter key and then the Up or Down key and the defrost will change to ON.

THERMO KING

Operating Instructions

Figure 10. Defrost On

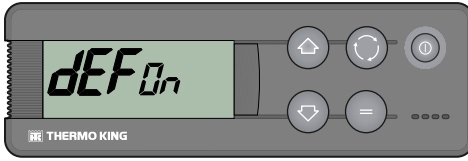

RCS372

3. Press the Select key twice to return to the Standard Display where the Defrost symbol will appear when the defrost cycle begins.

Note: Manual defrost will be aborted if there is no ice on the coil.

Important: The evaporator coil must be below 36°F (2.26°C) for a defrost to be enabled.

Figure 11. Defrost Cycle in Process

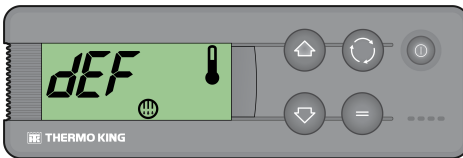

RCS433

Alarms

When the unit is not operating properly, the microprocessor records the alarm code, alerts the operator by displaying the Alarm symbol, and shuts the unit down. Press and release the Select key to display the current alarm code. If there is more than one active alarm, all the alarm codes on the unit can be viewed in sequence by pressing and releasing the Select key. Refer to (["Alarm Code Descriptions," p. 31](#)).

Auto Start (after an alarm)

When an alarm stops unit operation, the Alarm icon appears on the Standard Display. After the condition that caused the alarm is corrected and the alarm has been cleared, the unit will start automatically. Refer to (["Alarm Code Descriptions," p. 31](#)).

Figure 12. Auto Start Alarm

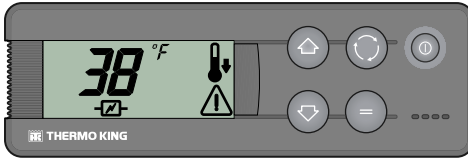

RCS368

Manual Start (after an alarm)

When a Manual Start alarm stops unit operation, the Alarm icon appears on the Standard Display with no other icons present.

Note: *This information applies only to the OL (Electric Standby overload) alarm and bAt (low battery voltage) alarm.*

After the condition that caused the alarm is corrected, the On/Off key on the In-cab Control Box must be pressed, in order to start unit operations. Once the unit is powered back up, the alarm must be cleared. Refer to ("[Clearing Alarm Codes](#)," p. 30).

Figure 13. Alarm Symbol

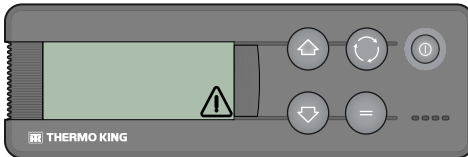

RCS370

Should a **P1E** alarm occur, return air temperature read error alarm code — will appear on display together with the alarm symbol, instead of the return air temperature reading.

Figure 14. P1E Alarm

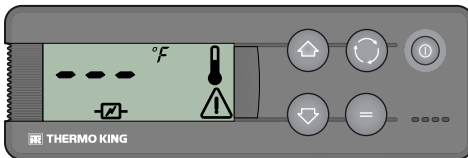

RCS369

Operating Instructions

Press and release the Select key to display the current alarm code. If there is more than one active alarm, all the alarm codes on the unit can be viewed in sequence by pressing and releasing the Select key.

Clearing Alarm Codes

The alarm condition in the unit must first be corrected. See important note below. After resolving the alarm condition, press and release the Select key to remove existing Alarm codes. The Standard Display will appear once the Alarm codes have been cleared.

To Clear Alarm Codes:

- Correct the cause of the alarm code.
- Press the Select key to remove the alarm code.
- If more than one alarm code is present, press the Select key to clear each alarm code individually.

Important: *Continually clearing alarm codes without resolving the problem will result in damage to the unit and compressor.*

Notes: *The bAt alarm is the unique DSR-III alarm that requires manual confirmation. The DSR-III will keep in OFF condition until the operator acknowledges and the voltage is above the BCH value(factory setting 10.5v).*

The way to acknowledge this alarm is as follows:

1. *Press the Select key once to show the Alarm screen. You will now see the bAt Alarm code.*
2. *Press the Select key again to acknowledge the alarm, and Press the select key again and again until the screen returns to the standard Display.*

Buzzers (Optional)

A buzzer sounds when the vehicle battery and the electrical supply are connected simultaneously (the unit continues running in standby mode). It can also sound if the door(s) is open or the return air temperature is out of range. Buzzers are configurable to different parameters to suit individual customer needs. Contact your Thermo King Dealer for assistance.

Alarm Code Descriptions

Table 1. Color Code Definitions

OK TO RUN	CHECK AS SPECIFIED	TAKE IMMEDIATE ACTION
-----------	--------------------	-----------------------

Alarm		Description
Manual Start		
bAt		Low Battery Voltage - Check vehicle battery.
Auto Start		
HP		High Pressure Alarm - The system has detected excessively high discharge pressure. <i>If the problem persists when the unit is restarted, contact your Thermo King Dealer.</i>
LP		Low Pressure Alarm - The system has detected excessively low suction pressure. <i>If the problem persists when the unit is restarted, contact your Thermo King Dealer.</i>
PSE		High Pressure Sensor Failure - The high pressure sensor has become faulty or disconnected. <i>Contact your Thermo King Dealer.</i>
dr1, dr2		Cargo Doors Are Open (Units with door switch option only) - Check if the Doors are open. if not, then the door switches are faulty, or improper door switch configuration. <i>Contact your Thermo King Dealer.</i>
tCO		Control Module Overheating <i>If the problem persists when the unit is restarted, contact your Thermo King Dealer.</i>
SOF		Software Failure <i>Contact your Thermo King Dealer.</i>
P1E		Faulty Cargo Box Return Air Temperature Sensor - Faulty or disconnected return air temperature sensor. <i>Contact your Thermo King Dealer.</i>
C		Communications Failure <i>Contact your Thermo King Dealer.</i>
H01		DSR communication lost - Communication lost to the other Electronic Control Module. <i>Contact your Thermo King Dealer.</i>
H02		HMI communication lost - Communication lost to the HMI. <i>Contact your Thermo King Dealer.</i>

Operating Instructions

Alarm	Description
H03	SCM communication lost - Communication lost to Smart Charger Module. <i>If the problem persists when the unit is restarted, contact your Thermo King Dealer.</i>
H04	CDM communication lost - Communication lost to Compressor Drive Module. <i>Contact your Thermo King Dealer.</i>
H0A	Low Power Mode Activation - ignition key of the vehicle is disconnected and the unit is not connected to the shore power. Operation of the unit may be inhibited but remains operational. <i>Report Alarm at the end of the day.</i>
H0B	Sleep Mode Activation - While the unit OFF, the vehicle battery voltage dropped below a threshold. Normal operation of the controller will resume as soon as the power is restored. <i>Report Alarm at the end of the day.</i>
H0C	Power Derating Shutdown - Low Voltage Shutdown alarm - your battery voltage has dropped below a defined level. The shutdown alarm is automatically cleared once the voltage rises over this limit once more. <i>Contact your Thermo King Dealer.</i>
H10	Internal flash erase error - Internal, System reset needed <i>Report Alarm at the end of the day.</i>
H12	Default parameters in use - This will typically happen after a new firmware version has been loaded. <i>If the problem persists when the unit is restarted, contact your Thermo King Dealer.</i>
H15	eMMC erase error - An error occurred while loading parameters to the DSR-IV Controller. <i>Internal, System reset needed, contact your Thermo King Dealer.</i>
H16	eMMC write error - An error occurred while loading parameters to the DSR-IV Controller or performing the datalogging process. <i>Internal, System reset needed, contact your Thermo King Dealer.</i>
H17	eMMC read error - An error during powering-up when reading configuration parameters. <i>Internal, System reset needed, contact your Thermo King Dealer.</i>
H18	Flash Loading Failed - An error occurred while loading firmware to the DSR-IV Controller. <i>Internal, System reset needed, contact your Thermo King Dealer.</i>
H1A	Non-Compatible SW - Indicates that one of the Electronic components contains an incorrect or out-of-date Software version. <i>Contact your Thermo King Dealer.</i>

Table 2. Compressor Drive Module Alarms

H21		Phase overcurrent - Shutdown alarm <i>Contact your Thermo King Dealer.</i>
H2A		Overcurrent of DC/DC converter - Shutdown alarm <i>Contact your Thermo King Dealer.</i>
H22		Input overvoltage - Shutdown alarm <i>Contact your Thermo King Dealer.</i>
H23		Input undervoltage - Consider let the engine run to allow the alternator to charge the vehicle battery. <i>Contact your Thermo King Dealer.</i>
H24		Motor Endstage temperature too high - Shutdown alarm <i>Contact your Thermo King Dealer.</i>
H25		Motor controller communication error - Critical, Motor controller alarm <i>Contact your Thermo King Dealer.</i>
H26		Locked Rotor - Critical, Motor controller alarm <i>Contact your Thermo King Dealer.</i>
H27		Compressor start-up failure - Critical, Motor controller alarm <i>Contact your Thermo King Dealer.</i>
H28		Phase Loss - One of the phases carrying current to the Compressor Drive Module (CDM) is disconnected. <i>Contact your Thermo King Dealer.</i>
H40		CFLT activated - Repeating non-critical alarms or a threshold of Active Alarms is reached which forces the unit to shutdown for maintenance. <i>Contact your Thermo King Dealer.</i>

Table 3. Battery Management Alarms

H50 to H5D		Battery internal alarm (Thermal or Voltage problem) - Shutdown alarm <i>Contact your Thermo King Dealer.</i>
H5E		Battery communications lost - Shutdown alarm <i>Contact your Thermo King Dealer.</i>
H5F		Low Battery warning. - Please connect your unit to shore power to charge the TK Battery. <i>If problem persists Contact your Thermo King Dealer.</i>
H60 to H63		Battery internal alarm (internal sensors) - Shutdown alarm <i>Contact your Thermo King Dealer.</i>

Operating Instructions

Table 3. Battery Management Alarms (continued)

H6B, H6C	Battery deeply discharged. - Please connect your unit to shore power to charge the TK Battery <i>If problem persists Contact your Thermo King Dealer.</i>
H6D	BMS communication lost. - Restart the E-200. <i>If problem persists Contact your Thermo King Dealer.</i>
H70 to H77	SCM Charging Condition. - Restart the E-200. <i>If problem persists Contact your Thermo King Dealer.</i>
H78, H79	Over Temperature in the Power Supply Unit (Main Unit) - Let the unit cool down, then restart the E-200. <i>If problem persists Contact your Thermo King Dealer.</i>
H7A, H7B	Relay Malfunction - Shutdown alarm <i>Contact your Thermo King Dealer.</i>
H7C, H7D	Batteries current imbalance warning (2 Battery Application ONLY) - Please connect E-200 to shore power to charge the TK battery. <i>If problem persists Contact your Thermo King Dealer.</i>

Viewing Information Displays

Main Menu

From the Standard Display use the Select key to display:

- Alarms (if any active)
- Defrost Status
- Temperature Setpoint

Hourmeter Menu

To open the Hourmeter Menu from the Standard Display, press the Select key for three seconds and release, then press the Select key to display:

- **HC:** Hours remaining to maintenance notice.
- **tH:** The total amount of time unit has been switched on.
- **CC:** Engine-driven compressor operating hours.
- **EC:** Electric standby compressor operating hours.

Unit Operation and Loading Procedures

This chapter describes unit operation and proper loading procedures. Thermo King refrigeration units are designed to maintain the required product load temperature during transit. Transport refrigeration units are not designed to reduce the load temperature. Follow these recommended procedures to help prevent cargo spoilage.

Unit Operation (Before Loading Refrigerated Cargo)

Start Unit: Adjust the thermostat setting to above and below the compartment temperature to check thermostat operation.

Pre-Cooling: With the thermostat set at the desired temperature, run the unit for half-an-hour to one hour (or until the desired setpoint is reached) before loading the refrigerated cargo. Pre-cooling eliminates residual heat and acts as a good test of the refrigeration system.

Defrost: When the unit has finished pre-cooling the cargo box the evaporator temperature should have dropped below 36°F (2.2°C). Initiate a manual defrost cycle with the In-Cab Controller. The defrost cycle will stop automatically.

Loading Procedure

Important: *Product should be pre-cooled before loading. Thermo King units are designed to maintain the load at the temperature at which it is loaded. Transport refrigeration units are not designed to reduce the load temperature.*

Note: *To minimize frost accumulation in the evaporator coil and a heat increase inside the load compartment, ensure that the unit is OFF before opening the doors.*

1. Carefully check and record the load temperature when loading the refrigerated cargo. Note whether any products are out of temperature range.
2. Load the product to verify sufficient air space is maintained around and through the load in compartment. Airflow around the cargo must not be restricted. DO NOT block the evaporator inlet or outlet. Refer to (Figure 15, p. 36).

Unit Operation and Loading Procedures

3. Minimize door opening times and close door(s) in between loading to preserve box temperature.

Figure 15. Air Circulation Diagram

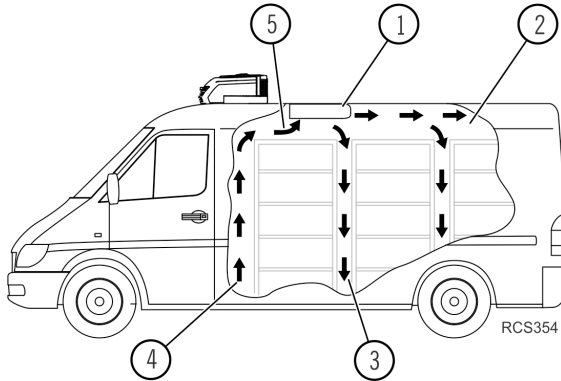

1.	Evaporator air outlet not blocked by cargo.
2.	Sufficient air space is maintained above cargo.
3.	Good air circulation around and between cargo.
4.	Cargo separated from bulkhead and walls a minimum of 4.00 inch (100 mm).
5.	Evaporator air inlet not blocked by cargo.

Enroute Inspections

To help prevent damage to the cargo, complete the following enroute inspection every four hours.

Inspection Procedure

1. Verify the setpoint is correct.
2. Check the return air temperature readings. The temperature readings should be within the desired temperature range. If the readings are not within this range, refer to (Table 4, p. 37).

Unit Operation and Loading Procedures

Inspection Troubleshooting

1. If a return air temperature reading is not within the desired temperature range, refer to (Table 4, p. 37). Correct the problem as needed.
2. Repeat the Enroute Inspection every 30 minutes until the compartment temperature is within the desired temperature range. Stop the unit if the compartment temperature is not within desired temperature range on two consecutive 30 minute inspections, especially if the compartment temperature appears to be moving away from the setpoint.
3. Immediately contact the nearest Thermo King Dealer.
4. Take the necessary steps to protect and maintain proper load temperature.

Table 4. Inspection Troubleshooting

Problem	Cause	Remedy
Return air temperature reading is not within desired temperature range of the setpoint.	Unit has not had time to cool cargo to correct temperature.	Refer to load log history. Look for above temperature load records, properly pre-cooled cargo compartment, length of time on road, etc. Correct as required. Continue monitoring return air temperature until reading is within desired temperature range of the setpoint.
	Unit may have a low refrigerant charge	Contact nearest Thermo King dealer, or call the Thermo King Cold Line for referral.
	Unit is in defrost or has just completed a defrost cycle.	Monitor return air temperature after defrost cycle is completed to see if temperature returns to desired temperature range of the setpoint. <i>Note: Temperature will increase slightly during defrost cycle.</i>
	Evaporator is plugged with frost.	Initiate a manual defrost cycle. Defrost cycle will automatically terminate when complete. Continue monitoring return air temperature until reading is within desired temperature range of the setpoint.

Unit Operation and Loading Procedures

Table 4. Inspection Troubleshooting (continued)

Problem	Cause	Remedy
Return air temperature reading is not within desired temperature range of the setpoint.	Improper air circulation in the cargo compartment.	<p>Inspect unit and cargo compartment to determine if evaporator fans are working and properly circulating the air. Poor air circulation may be due to improper loading of the cargo or shifting of the load. Correct as required. Continue monitoring return air temperature until problem is corrected.</p> <div style="border: 1px solid black; padding: 5px; text-align: center;"> <p>⚠ CAUTION</p> <p>Risk of Injury!</p> <p>The unit can start and run automatically any time the unit is turned on. Turn the unit On/Off switch Off before doing inspections or working on any part of the unit. Please note that only Qualified and Certified personnel should attempt to service your Thermo King unit.</p> </div>
	The unit did not start automatically.	Contact nearest Thermo King dealer, or call the Thermo King Cold Line for referral.
	Air leaks in cargo box.	Inspect cargo box for air leaks such as doors that are not fully closed or bad/missing door seals. Repair as necessary.

Specifications

Refrigeration System

Contact your Thermo King dealer for refrigeration system service or maintenance.

Compressor

Compressor Type	Electrical hermetic compressor, rotary type
Oil Type	PVE

Electrical Control System

The unit's controls and refrigeration components operate on 12 Vdc.	
Fuses	
Fuse 1: Main Fuse	150 amps
Fuse 3: Evaporator Fan	15 amps
Fuse 4: Evaporator second Fan	15 amps
Fuse 5: Distribution fuse	20 amps
Fuse 6: Drain Heaters	2 amps
Fuse 9: Evaporator Fan second compartment	15 amps
Fuse 11: Drain Heaters second compartment	2 amps
Fuse 14: ACC1 Ignition Fuse	5 amps
Fuse 25: Vehicle Battery	5 amps
Fuse 63:	1 Battery
Fuse 83:	2 Battery
Fuse 71: SCM Fuse	60 amps
Fuse 72: SCM Fuse	60 amps
Fuse 8:	BMS Fuses
Fuse 84:	

Specifications

Condenser Fan Motor	
Voltage	13 Vdc
Full Load Current	11 Amps
Power Rating	145 W
RPM with Full Load	2,670

Evaporator Fan Motors (Each)	
Voltage	13 Vdc
Full Load Current	7.5 Amps
Power Rating	97.5 W
RPM with Full Load	2,800

Compressor Drive Module	
Battery Input	11.5 to 14.5 Vdc
Isolated, balanced three-phase output:	240 VAC Maximum
	30–300 Hz (speed controlled)
Electrical output power:	1150 W continuous, 1400 W for 30 seconds

Smart Charger Module	
Bidirectional Battery Charger / Discharger	
Voltage	13 Vdc
Maximum Charge Current	40 A dc
Maximum Discharge Current	40 A dc

Electric Standby Power Supply Requirements

				Power Cord Length Power Cord Size (AWG)		
Voltage	Phase	Hz	Power Supply Circuit Breaker	25 ft.	50 ft.	100 ft.
230 (Vac)	1	50/60	20 amp	AWG12	AWG10	AWG8
115 (Vac)	1	50/60	20 amp	AWG12	AWG10	AWG8

Important: Failure to use properly sized power cord may result in improper unit operation, or unit failure.

Standby Power Plug Wiring

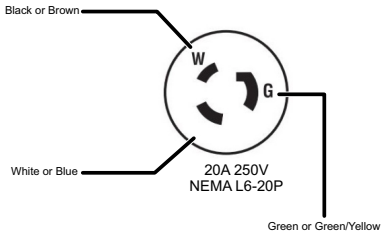
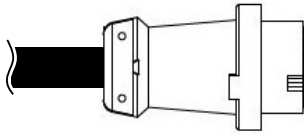

115V/1PH

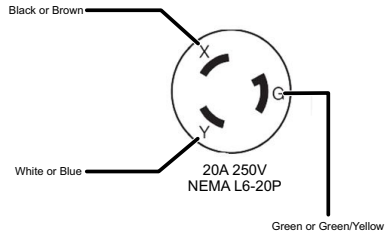

230V/1PH

RCS1714

Inspection and Service Intervals

Weekly Pre-Trip Checks

1. Listen for unusual noises, vibrations, etc.
2. Visually inspect unit for fluid leaks (coolant, oil, refrigerant).
3. Visually inspect unit for damaged, loose or broken parts (including air ducts and bulkheads, if so equipped).
4. In the event of excess of dirt or obstruction clean the unit, including condenser and evaporator coils.

Weekly Pretrip Inspection

The following Weekly Pretrip Inspection should be completed before starting the unit and loading the truck. While the weekly inspection is not a substitute for regularly scheduled maintenance inspections, it is an important part of the preventive maintenance program designed to head off operating problems before they happen.

Leaks: Inspect for refrigerant leaks and worn refrigerant lines.

Battery: Terminals should be properly tightened and show no signs of corrosion.

Belts: Inspect for cracks, wear, and proper belt tension.

Mounting Bolts: Verify bolts are properly tightened.

Electrical: Electrical connections should be securely fastened. Wires and terminals should be free of corrosion, cracks, or moisture.

Structural: Visually check for physical damage.

Coils: The condenser and evaporator coils should be clean and free of debris.

- Washing with clean water should be sufficient. The use of cleaning agents or detergents is strongly discouraged due to the possibility of degradation of the construction. If using a power washer, the nozzle pressure should not exceed 600 psi (41 bar). For the best results, spray the coil perpendicular to the face of the coil. The spray nozzle should be kept between 1 inch and 3 inches (25 to 75 millimeters) from the coil surface. If necessary to use a chemical cleaner or detergent use a cleaner that does not contain any hydrofluoric acids and is between 7 and 8 on the pH scale. Ensure dilution instructions provided by the detergent supplier are followed. In case of doubt about the compatibility of the detergent with the type of materials listed above, always ask the supplier

a written confirmation of the compatibility. Should a chemical cleaner be required, it is MANDATORY that all components are thoroughly rinsed with water even if the instructions of the cleaner specify that it is a “no rinse” cleaner. Failure to comply with above mentioned guidelines will lead to a shortened life of the equipment to an indeterminable degree. The repeated transportation of meat and fish waste can cause extensive corrosion to the evaporator coils and evaporator section tubing over time due to ammonia formation and can reduce the lifespan of the coils. Appropriate additional measures should be taken to protect the coils against the aggressive corrosion that can result from transportation of such products.

Load Compartment: Inspect the interior and exterior of the truck for any damage. Any damage to the walls or insulation should be repaired.

Defrost Drains: Check the defrost drain hoses and fittings to ensure they are not blocked.

Doors: Verify doors and weather seals are in good condition and seal hermetically.

Sight glass: Check that the refrigerant charge sight glass on the running unit is totally full (the cargo compartment temperature must be approximately 0°C).

Weekly Post-Trip Checks

NOTICE

Equipment Damage!

Do not use pressurised water.

1. Clean the outside cover of the unit. Use a damp cloth and neutral detergents. Do not use harsh cleaning products or solvents.
2. Check for leaks.
3. Check for loose or missing hardware.
4. Check for physical damage to the unit.

Inspection and Service Schedules

To ensure that your Thermo King unit operates reliably and economically over its full life, and to avoid limiting its warranty cover, the appropriate inspection and service schedule must be followed. Inspection and Service intervals are determined by the number of unit operating hours and by the age of the unit. Examples are shown in the table below. Your Dealer will prepare a schedule to suit your specific needs.

Operat- ing Hours per Year	1000	2000	3000
Inspection	6 months/ 500 hours		
Inspection	12 months/ 1000 hours (+ preventative maintenance)	6 months/ 1000 hours	4 months/ 1000 hours
Inspection	18 months/ 1500 hours	12 months/ 2000 hours (+ preventative maintenance)	8 months/ 2000 hours
Full Service	24 months/ 2000 hours	18 months/ 3000 hours	12 months/ 3000 hours (+ preventative maintenance)
	(continue as above)	(continue as above)	(continue as above)

Service Record

Each inspection and service performed should be recorded on the Service Record Sheet found at the back of this manual.

Preventative Maintenance

Refer to the previous page for checks that should be carried out daily/weekly on the unit. Please work with your Dealer in order to create a maintenance schedule which fits your needs.

Thermo King has extended the limited warranty on new units from 3,000 total hours to a maximum of 4,000 compressor run hours within the 2 year warranty period.

This limited warranty is dependent on the owner and/ or operator adhering to the preventative maintenance schedule as advised by your Thermo King Dealer.

Warranty

Terms of the Thermo King North American Vehicle Powered Truck Unit Limited Warranty are available on request from your Thermo King Dealer. Please reference document TK 51350.

Proposition 65

 **WARNING:**
Cancer and Reproductive Harm
www.P65Warnings.ca.gov

RCS1032

Serial Number Locations

1. **CONDENSER:** Nameplate located on the back of the condenser frame (cover needs to be removed to access).
2. **INVERTER DRIVEN COMPRESSOR:** Nameplate located on compressor body. Inverter driven compressor is located in the Compressor Drive Module.
3. **SMART CHARGER MODULE (SCM):** Nameplate location as shown below.
4. **SECOND UNIT NAMEPLATE:** A second unit serial number nameplate is typically located inside the vehicle's door opening area. This nameplate provides quick and easy access to the same unit serial number found on the condenser unit.

Figure 16. Condenser Serial Number Location

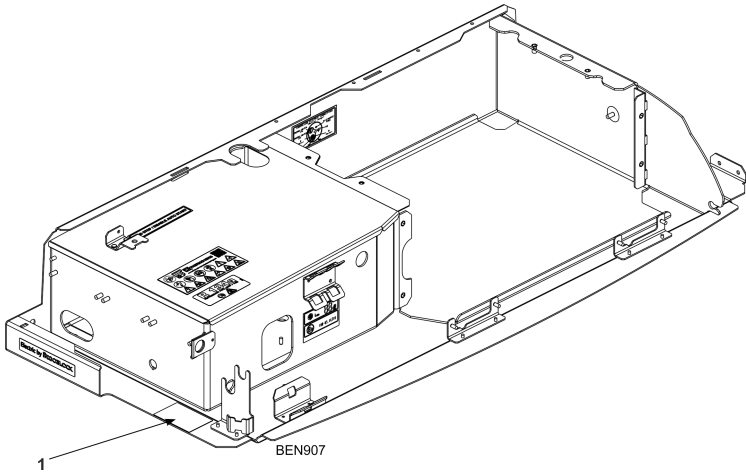

Figure 17. Hermetic Compressor Serial Number Location

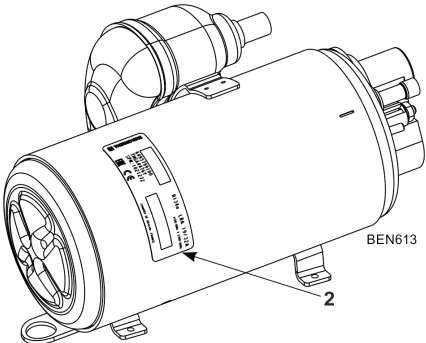

Figure 18. Smart Charger Module Serial Number Location

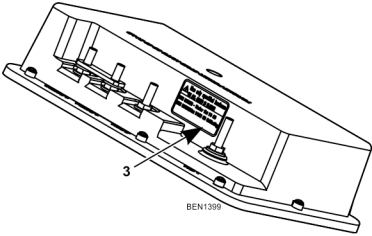

Figure 19. Second Unit Nameplate



Recover Refrigerant

At Thermo King®, we recognize the need to preserve the environment and limit the potential harm to the ozone layer that can result from allowing refrigerant to escape into the atmosphere.

We strictly adhere to a policy that promotes the recovery and limits the loss of refrigerant into the atmosphere.

In addition, service personnel must be aware of Federal regulations concerning the use of refrigerants and the certification of technicians. For additional information on regulations and technician certification programs, contact your local THERMO KING dealer.

Emergency Cold Line

If you can't get your unit operating and need assistance, you can locate a Thermo King Dealer anywhere in the United States by going to thermoking.com or by using the Thermo King North American Service Directory (available from any Thermo King dealer). If you are unable to reach a dealer, then call the Toll Free Emergency Cold Line Number (888) 887-2202. The answering service will assist you in reaching a dealer to get the help you need. The Cold Line is answered 24 hours a day by personnel who will do their best to get you quick service at an authorized Thermo King Dealer



Thermo King – by Trane Technologies (NYSE: TT), a global climate innovator – is a worldwide leader in sustainable transport temperature control solutions. Thermo King has been providing transport temperature control solutions for a variety of applications, including trailers, truck bodies, buses, air, shipboard containers and railway cars since 1938. For more information, visit www.thermoking.com or www.tranetechnologies.com.

Thermo King has a policy of continuous product and product data improvements and reserves the right to change design and specifications without notice. We are committed to using environmentally conscious print practices.